

Top View

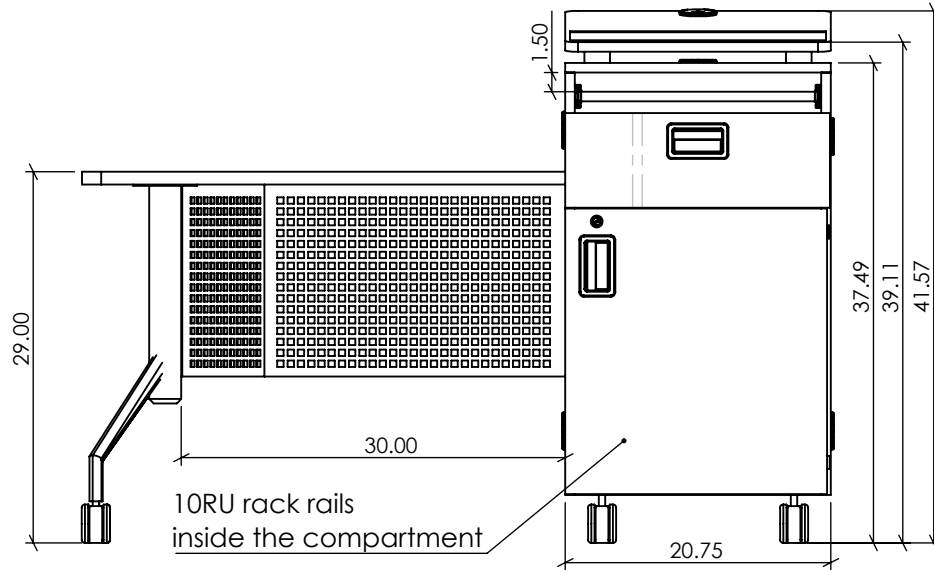

Presenter View

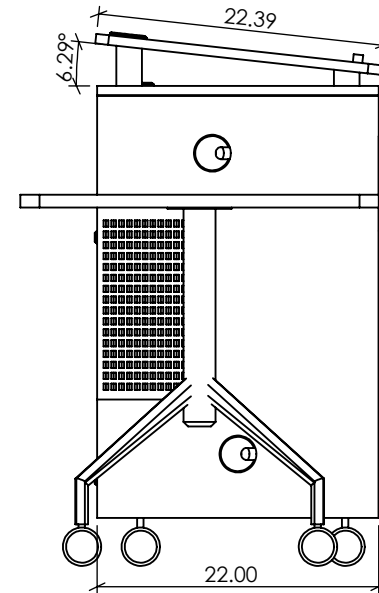

Left View



TITLE:  
PMT-100-C-LT

SCALE: 1:15	Date: March 18, 2021	SIGN OFF:
WEIGHT:	Customer:	
SHEET 1 OF 3	Model: Casters	

SIZE	DWG. NO.	REV
------	----------	-----

A

FINISH	COMMENTS:
--------	-----------

**PROPRIETARY AND CONFIDENTIAL:**

- The information in this drawing is the sole property of Exact Furniture Limited.  
- Specification subject to change without notice

DO NOT SCALE DRAWING

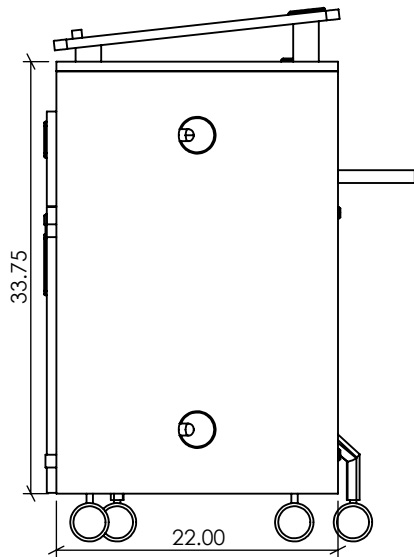

Right View

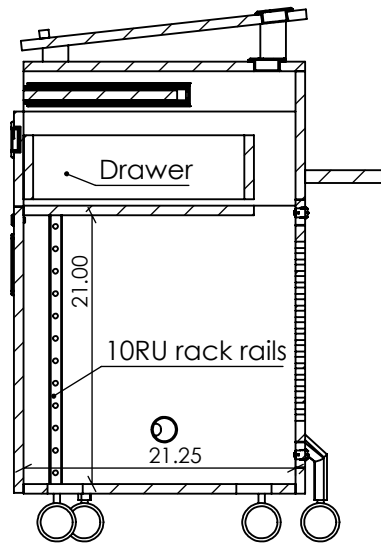

SECTION A-A

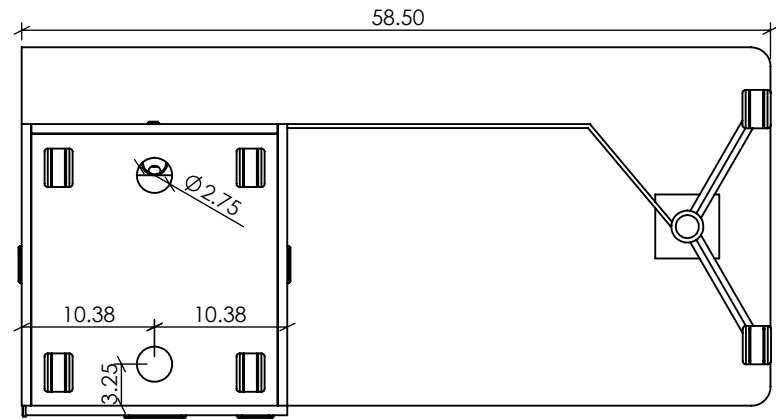

Bottom View

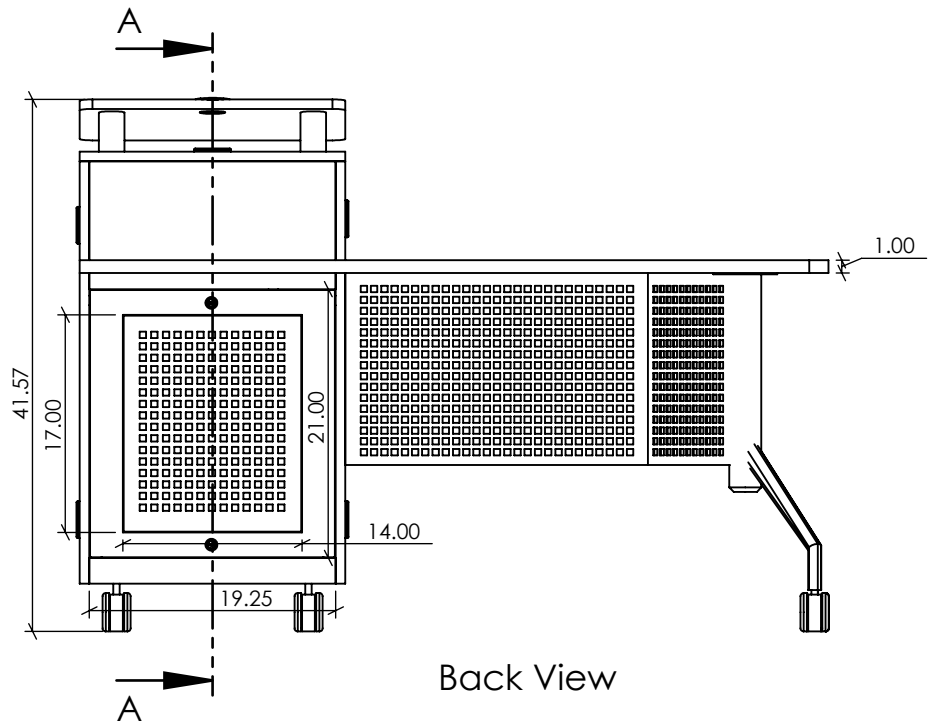

Back View



TITLE:  
PMT-100-C-R

SCALE: 1:15	Date: March 18, 2021	SIGN OFF:
WEIGHT:	Customer:	
SHEET 2 OF 3	Model: Casters	

SIZE	DWG. NO.	REV
A		

FINISH	COMMENTS:
--------	-----------

**PROPRIETARY AND CONFIDENTIAL:**

- The information in this drawing is the sole property of Exact Furniture Limited.  
- Specification subject to change without notice

DO NOT SCALE DRAWING

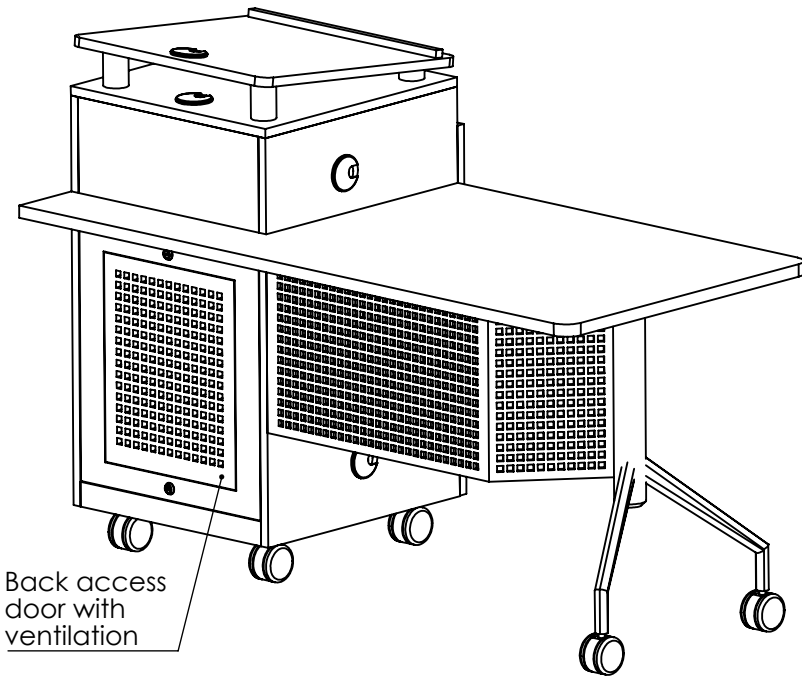

Back access door with ventilation

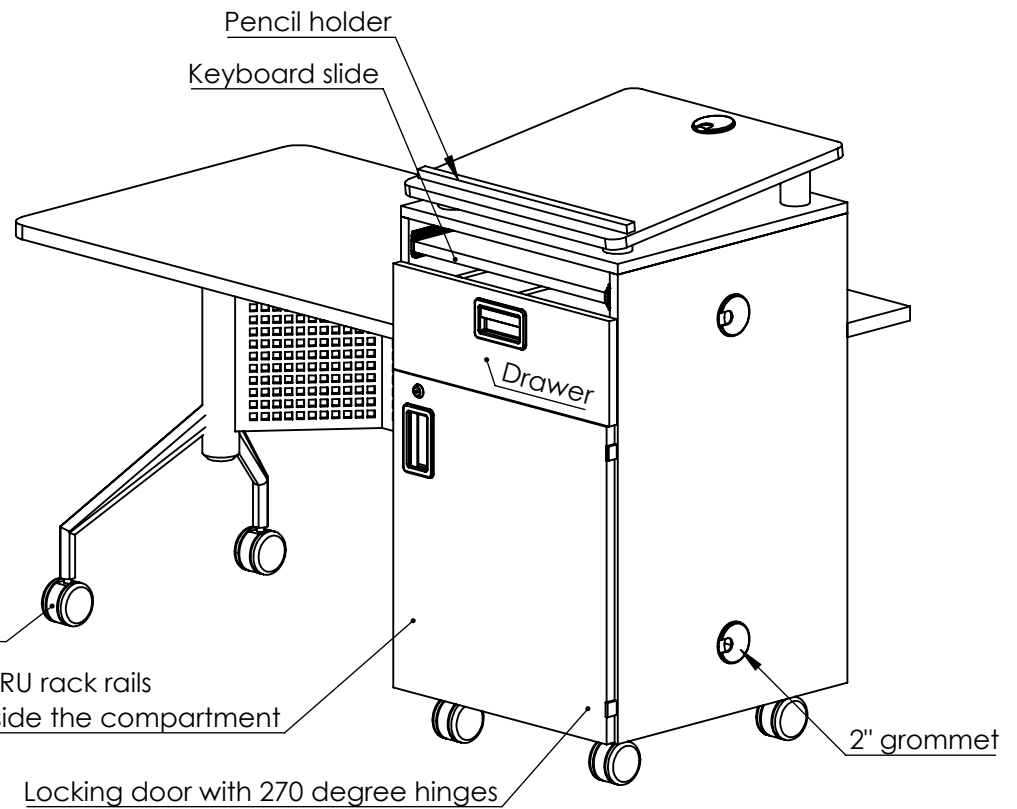

Pencil holder  
Keyboard slide

Lockable Casters

10RU rack rails inside the compartment

Locking door with 270 degree hinges

2" grommet



TITLE:  
PMT-100-C-LT

SCALE: 1:15	Date: March 18, 2021	SIGN OFF:
WEIGHT:	Customer:	
SHEET 3 OF 3	Model: Casters	

SIZE	DWG. NO.	REV
------	----------	-----

A

FINISH COMMENTS:

**PROPRIETARY AND CONFIDENTIAL:**

- The information in this drawing is the sole property of Exact Furniture Limited.  
- Specification subject to change without notice

DO NOT SCALE DRAWING